

PERFILES PARA PORTALES  
DOOR PROFILES



**SISTEMAS ALUMISAN**

TUBOS Y CHAPAS DE ALUMINIO

PERFILES PARA PORTALES  
DOOR PROFILES

—	<b>MARCO PORTAL 50 MM</b> 50 MM GATE FRAME	03
—	<b>MARCO PORTAL 56,1 MM</b> 56,1 MM GATE FRAME	03
—	<b>HOJA PORTAL 101 MM</b> 101 MM GATE SHEET	03
—	<b>JUNQUILLO PORTAL 101 MM</b> 101 MM GATE JONQUIL	03
—	<b>MARCO TRAVESAÑO PORTAL DE 80 MM</b> 80 MM GATE FRAME CROSSBAR	04
—	<b>GUÍA PORTAL CORREDERA</b> SLIDING DOOR GUIDE	04
—	<b>MARCO PORTAL 80 MM CON PESTAÑA</b> 80 MM GATE FRAME WITH FLANGE	04
—	<b>MARCO PORTAL 80 MM</b> 80 MM GATE FRAME	04
—	<b>MARCO CANCELLA 70 MM CON PESTAÑA CURVA</b> 70 MM GATE FRAME WITH CURVE FLANGE	05
—	<b>MARCO CANCELLA 70 MM CON PESTAÑA RECTA</b> 70 MM GATE FRAME WITH STRAIGHT FLANGE	05
—	<b>CHAPA DOS PAÑOS</b> TWO PIECES SHEET	05
—	<b>BATIENTE PORTAL CORREDERA</b> SLIDING DOOR JAMP	05
—	<b>LAMA PORTAL DE 100 MM</b> 100 MM SLAT GATE	06
—	<b>LAMA PORTAL DE 200 MM</b> 200 MM SLAT GATE	06
—	<b>LAMA PORTAL DE 200 X 26 MM</b> 200 X 26 MM SLAT GATE	06
—	<b>TABLILLA 200 MM CON PORTA-TORNILLO</b> 200 MM SLAT GATE WITH SCREW-HOLDER	06

## MARCO PORTAL 50 MM

50 MM GATE FRAME

REF.

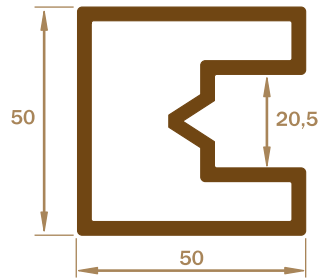
**1330**ESPESOR  
THICKNESS **3MM**

## MARCO PORTAL 56,1 MM

56,1 MM GATE FRAME

REF.

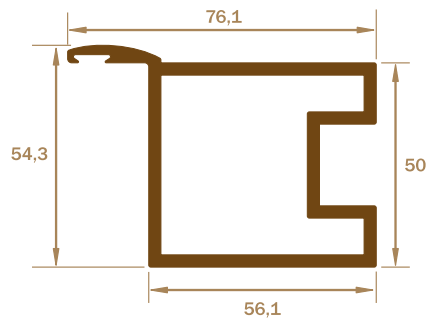
**3699**ESPESOR  
THICKNESS **3MM**

## HOJA PORTAL 101 MM

101 MM GATE SHEET

REF.

**2245**ESPESOR  
THICKNESS **3MM**

## JUNQUILLO PORTAL DE 101 MM

101 MM GATE JONQUIL

REF.

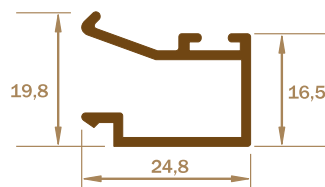
**2065**ESPESOR  
THICKNESS **1,3MM**

**MARCO TRAVESAÑO PORTAL DE 80 MM**  
 80 MM GATE FRAME CROSSBAR

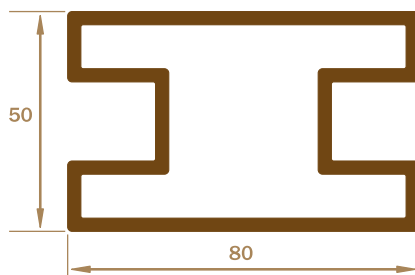
 REF.  
**3551**

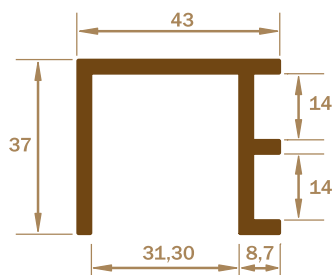
 ESPESOR  
 THICKNESS **3MM**
**GUÍA PORTAL CORREDERA**  
 SLIDING DOOR GUIDE

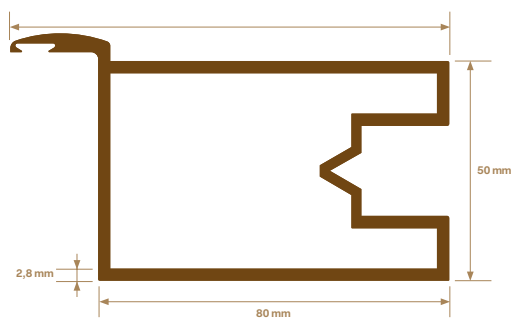
 REF.  
**3659**

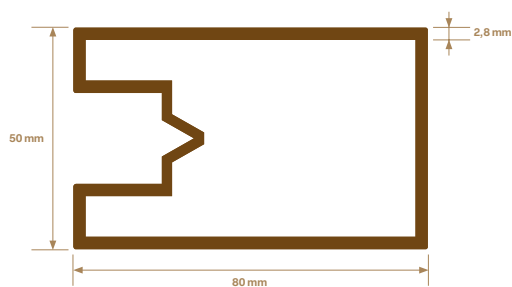
 ESPESOR  
 THICKNESS **3MM**
**MARCO PORTAL 80 MM CON PESTAÑA**  
 80 MM GATE FRAME WITH FLANGE

 REF.  
**3549**

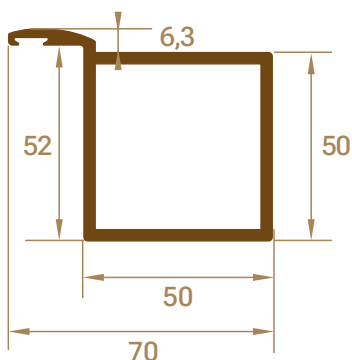
 ESPESOR  
 THICKNESS **2,8MM**
**MARCO PORTAL 80 MM**  
 80 MM GATE FRAME

 REF.  
**3550**

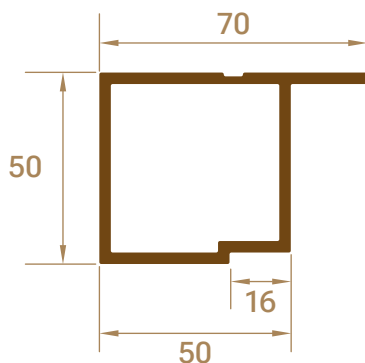
 ESPESOR  
 THICKNESS **2,8MM**

**MARCO CANCELLA 70 MM CON PESTAÑA CURVA**  
 70 MM GATE FRAME WITH CURVE FLANGE

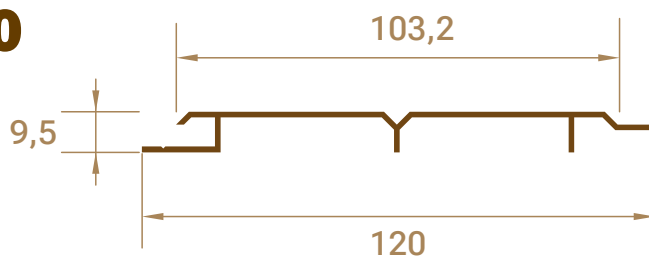
 REF.  
**8791**

 ESPESOR  
 THICKNESS | **3MM**
**MARCO CANCELLA 70 MM CON PESTAÑA RECTA**  
 70 MM GATE FRAME WITH STRAIGHT FLANGE

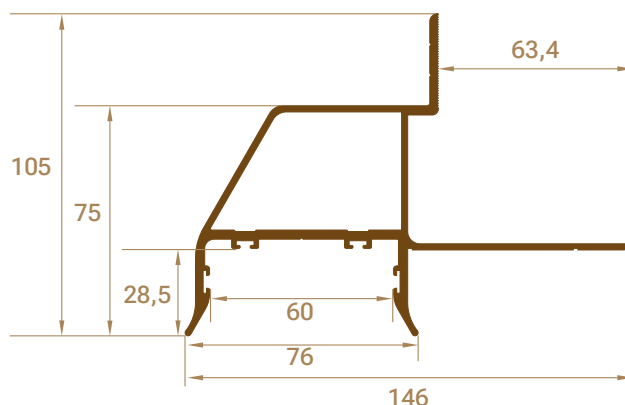
 REF.  
**5291**

 ESPESOR  
 THICKNESS | **3MM**
**CHAPA DOS PAÑOS**  
 TWO PIECES SHEET

 REF.  
**0740**

 ESPESOR  
 THICKNESS | **1,3MM**
**BATIENTE PORTAL CORREDERA**  
 SLIDING DOOR JAMP

 REF.  
**4272**

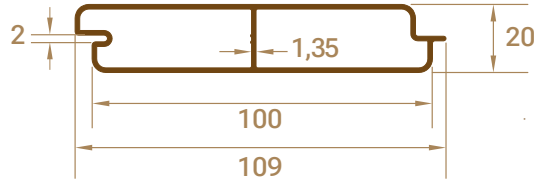
 ESPESOR  
 THICKNESS | **2/3MM**

**LAMA PORTAL DE 100 MM**  
 100 MM SLAT GATE

REF.

**3503**
 ESPESOR  
 THICKNESS | **1,35 MM**
**LAMA PORTAL DE 200 MM**  
 200 MM SLAT GATE

REF.

**1190**
 ESPESOR  
 THICKNESS | **1,5MM**
**LAMA PORTAL DE 200 X 26 MM**  
 200 X 26 MM SLAT GATE

REF.

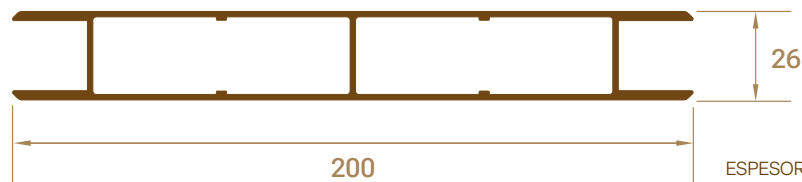
**1197**
 ESPESOR  
 THICKNESS | **1,5MM**
**TABLILLA 200 MM CON PORTA-TORNILLO**  
 200 MM SLAT GATE WITH SCREW-HOLDER

REF.

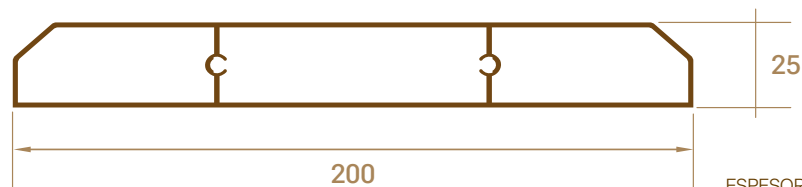
**1191**
 ESPESOR  
 THICKNESS | **1,6MM**

*30 años haciendo historia...*

# SISTEMAS ALUMISAN

SANTIAGO DE COMPOSTELA | LUGO | AVILÉS | SALAMANCA | BILBAO | MADRID

**GRUPO ALUMISAN**

[www.alumisan.com](http://www.alumisan.com)